

Installationsvejledning
Montageanweisung
Installation instruction
Instructions d'installation
Istruzioni di installazione
Installatie- -instructies
Instrucciones de instalación

damixa™

Hvidkærvej 48, 5250 Odense SV
 Tlf. +45 88 33 00 34
 damixa-international@fmm-mora.com
 www.damixa.com

09.21

12545.00

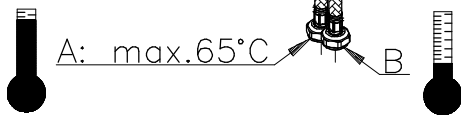
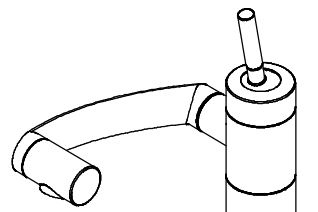
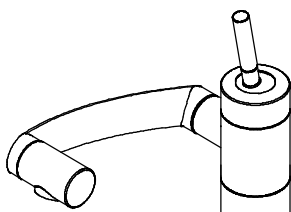
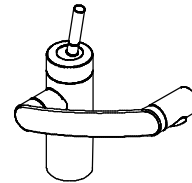
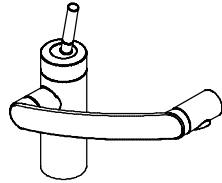

A,B: 50–1000 kPa (0.5–10 bar)

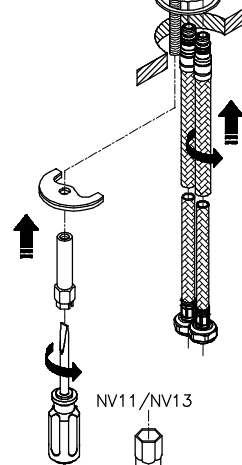
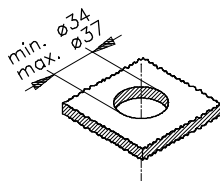

1

NV11/NV13

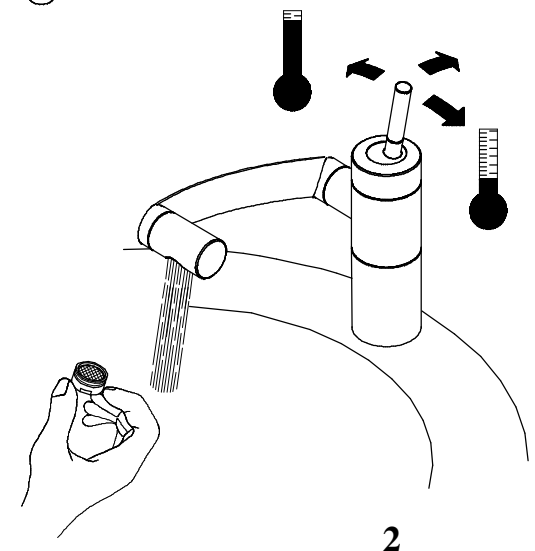
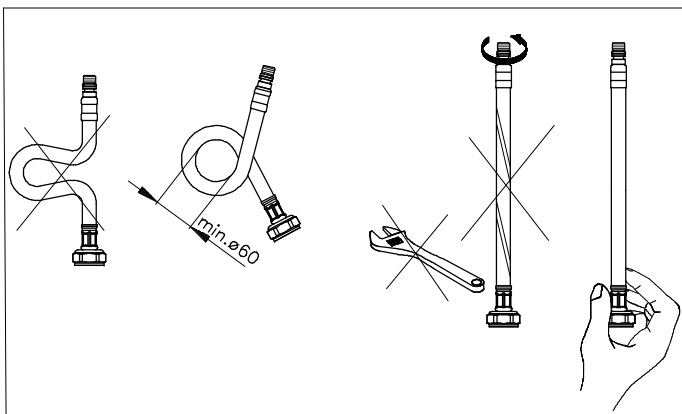

2

